

Lag 3
Skive 1

Sakskøbing 10m Åben 2018-1Stev - Sakskøbing Skytteforening

Hanne Andersen
Tingsted Skytteforening

Klasse R-S1

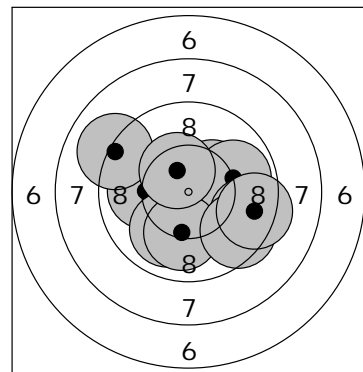

| | | | |
|---|-------|----|-------|
| 1 | X.0 ← | 6 | 9.0 ← |
| 2 | *.3 ↗ | 7 | X.0 ↓ |
| 3 | 9.9 → | 8 | 9.5 ↘ |
| 4 | X.0 ↓ | 9 | *.4 ↖ |
| 5 | 9.5 → | 10 | 9.4 → |

Match
S-10: 98.0

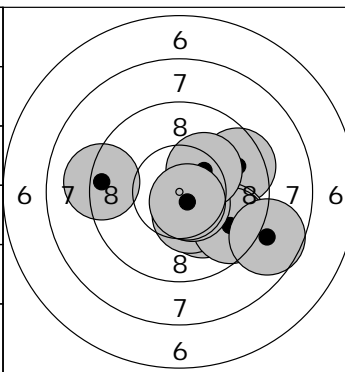

| | | | |
|----|-------|----|-------|
| 31 | X.1 ↘ | 36 | 9.5 ↘ |
| 32 | 9.5 ↗ | 37 | 8.7 ↘ |
| 33 | 9.6 ↘ | 38 | *.6 ○ |
| 34 | *.4 ↓ | 39 | *.2 ↗ |
| 35 | 9.1 ← | 40 | *.7 ○ |

Match
S-10: 98.4 SUM: 390.7 (11) TOT: 390.7 (11)

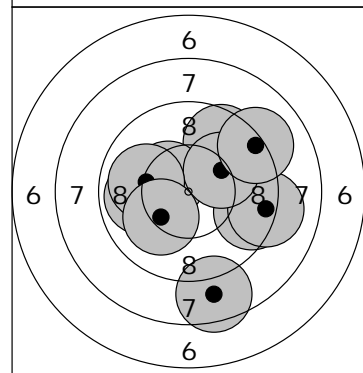

| | | | |
|----|-------|----|-------|
| 11 | 9.6 ↖ | 16 | X.0 ↗ |
| 12 | 9.9 ← | 17 | 9.1 ↗ |
| 13 | 9.4 → | 18 | 9.9 ← |
| 14 | *.4 ↖ | 19 | X.1 ↙ |
| 15 | 9.1 → | 20 | 8.5 ↓ |

Match
S-10: 96.0

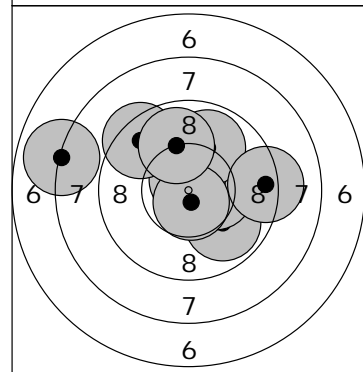

| | | | |
|----|-------|----|-------|
| 21 | *.4 → | 26 | 9.4 ↖ |
| 22 | 9.9 ↘ | 27 | 9.9 ↖ |
| 23 | *.3 → | 28 | *.7 ○ |
| 24 | 7.9 ← | 29 | 9.9 ↖ |
| 25 | *.7 ○ | 30 | 9.2 → |

Match
S-10: 98.3

Lag 3 Skive 2

Sakskøbing 10m Åben 2018-1Stev - Sakskøbing Skytteforening

Poul Erik Hansen
Væggerløse Skytteforening

Klasse R-OB

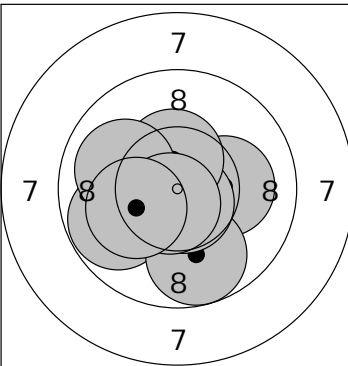

| | | | |
|---|-------|----|-------|
| 1 | X.1 → | 6 | *.7 ○ |
| 2 | *.6 ○ | 7 | *.4 ↑ |
| 3 | *.7 ○ | 8 | X.0 ← |
| 4 | 9.8 ← | 9 | *.7 ○ |
| 5 | 9.8 ↓ | 10 | *.2 ← |

Match
S-10: 103.0

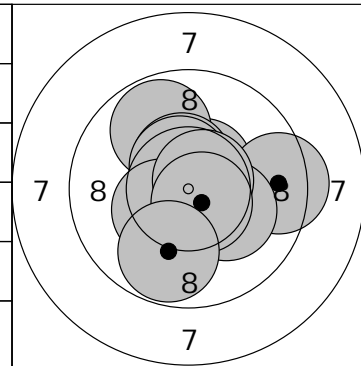

| | | | |
|----|-------|----|-------|
| 31 | *.5 ↗ | 36 | *.2 ↘ |
| 32 | 9.8 ↗ | 37 | *.4 ↙ |
| 33 | *.5 ↑ | 38 | *.7 ○ |
| 34 | *.5 ↑ | 39 | *.6 ○ |
| 35 | 9.4 → | 40 | 9.8 ↓ |

Match
S-10: 102.4 SUM: 406.3 (22) TOT: 406.3 (22)

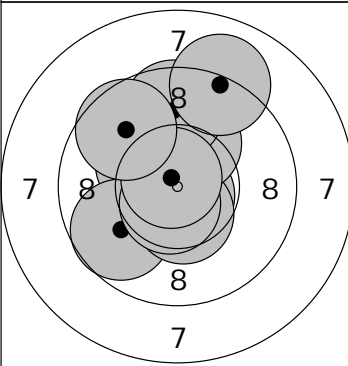

| | | | |
|----|-------|----|-------|
| 11 | *.3 ↖ | 16 | *.2 ↑ |
| 12 | 9.7 ← | 17 | 9.6 ↑ |
| 13 | *.8 ○ | 18 | *.8 ○ |
| 14 | *.5 ↓ | 19 | 9.6 ↗ |
| 15 | *.6 ○ | 20 | 9.0 ↑ |

Match
S-10: 101.1

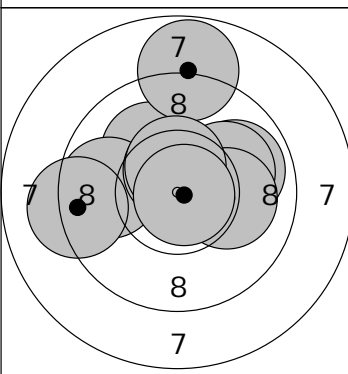

| | | | |
|----|-------|----|-------|
| 21 | 9.9 → | 26 | 8.8 ↑ |
| 22 | X.1 ↗ | 27 | X.1 → |
| 23 | 9.7 ← | 28 | *.6 ○ |
| 24 | X.1 → | 29 | *.5 ↑ |
| 25 | 9.2 ← | 30 | *.8 ○ |

Match
S-10: 99.8

Lag 3 Skive 3

Sakskøbing 10m Åben 2018-1Stev - Sakskøbing Skytteforening

Karen Lolle
Væggerløse Skytteforening

Klasse R-Å

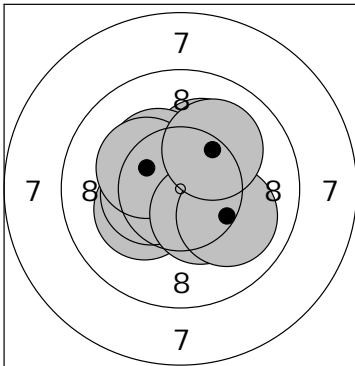

| | | | | | |
|---|-------|--|----|-------|--|
| 1 | *.2 ↙ | | 6 | *.8 ○ | |
| 2 | *.4 ← | | 7 | *.3 ↖ | |
| 3 | *.7 ○ | | 8 | *.4 ↘ | |
| 4 | *.2 ↗ | | 9 | X.0 → | |
| 5 | *.3 ↗ | | 10 | X.1 ↗ | |

Match
S-10: 103.4

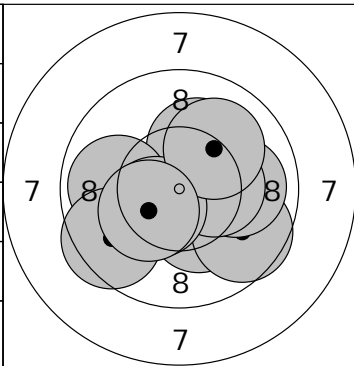

| | | | | | |
|----|-------|--|----|-------|--|
| 31 | *.2 ↗ | | 36 | 9.9 ← | |
| 32 | *.3 ↘ | | 37 | *.4 ↙ | |
| 33 | 9.6 ↘ | | 38 | 9.5 ↙ | |
| 34 | X.0 → | | 39 | X.0 ↗ | |
| 35 | *.3 → | | 40 | *.3 ↙ | |

Match
S-10: 100.5 SUM: 410.6 (27) TOT: 410.6 (27)

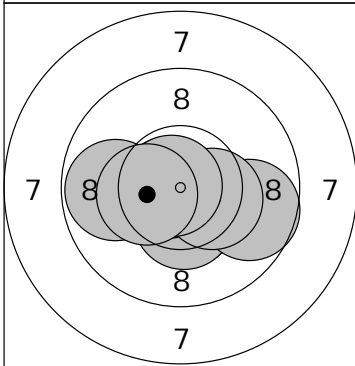

| | | | | | |
|----|-------|--|----|-------|--|
| 11 | *.7 ○ | | 16 | 9.8 ← | |
| 12 | *.8 ○ | | 17 | *.7 ○ | |
| 13 | *.4 ↓ | | 18 | *.4 → | |
| 14 | *.4 ↓ | | 19 | *.8 ○ | |
| 15 | 9.7 → | | 20 | *.4 ← | |

Match
S-10: 104.1

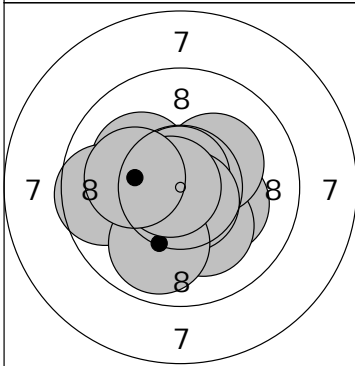

| | | | | | |
|----|-------|--|----|-------|--|
| 21 | *.2 → | | 26 | 9.6 ← | |
| 22 | X.1 ↖ | | 27 | *.7 ○ | |
| 23 | *.2 ↓ | | 28 | 9.9 ↓ | |
| 24 | *.2 ↗ | | 29 | *.8 ○ | |
| 25 | *.8 ○ | | 30 | X.1 ← | |

Match
S-10: 102.6

Lag 3
Skive 4

Sakskøbing 10m Åben 2018-1Stev - Sakskøbing Skytteforening

Oliver Dall Hansen
Ølstykke Skytteforening

Klasse R-U17-F

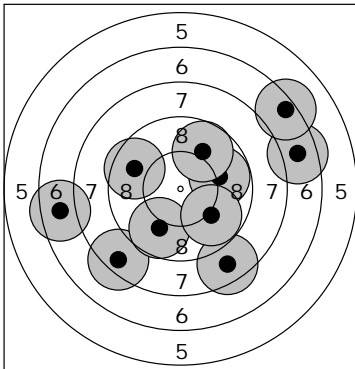

| | | | | | |
|---|-----|---|----|-----|---|
| 1 | 9.5 | ← | 6 | 9.7 | ↓ |
| 2 | 8.2 | ↙ | 7 | 8.4 | ↘ |
| 3 | 9.8 | → | 8 | 7.4 | → |
| 4 | 7.4 | ← | 9 | 7.2 | ↗ |
| 5 | 9.7 | ↗ | 10 | 9.8 | ↘ |

Match

S-10: 87.1

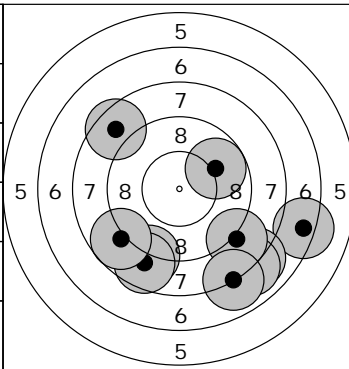

| | | | | | |
|----|-----|---|----|-----|---|
| 31 | 7.2 | → | 36 | 8.7 | ↙ |
| 32 | 8.8 | ↙ | 37 | 8.8 | ↘ |
| 33 | 8.0 | ↘ | 38 | 7.9 | ↘ |
| 34 | 8.6 | ↙ | 39 | 8.4 | ↖ |
| 35 | 8.0 | ↘ | 40 | 9.8 | ↗ |

Match

S-10: 84.2 SUM: 349.7 (1) TOT: 349.7 (1)

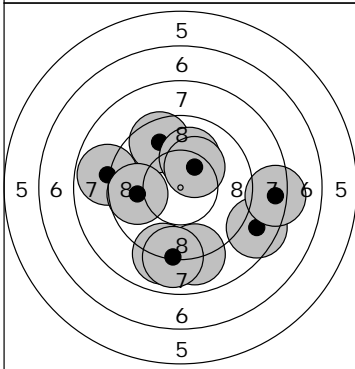

| | | | | | |
|----|-----|---|----|-----|---|
| 11 | 8.5 | → | 16 | 9.0 | ↓ |
| 12 | 9.5 | ↗ | 17 | 8.2 | → |
| 13 | X.1 | ↗ | 18 | 9.7 | ← |
| 14 | 8.8 | ← | 19 | 9.0 | ↓ |
| 15 | *.2 | ↗ | 20 | 8.9 | ↓ |

Match

S-10: 91.9

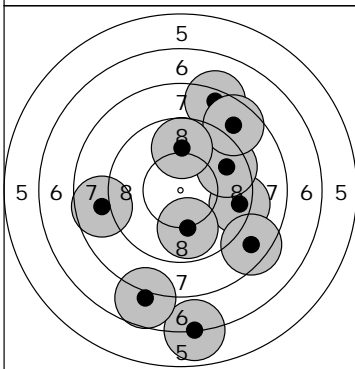

| | | | | | |
|----|-----|---|----|-----|---|
| 21 | 6.9 | ↓ | 26 | 8.6 | ← |
| 22 | 9.2 | → | 27 | 8.5 | ↗ |
| 23 | 8.2 | ↗ | 28 | 9.7 | ↑ |
| 24 | 9.5 | ↗ | 29 | 9.8 | ↓ |
| 25 | 7.7 | ↓ | 30 | 8.4 | ↘ |

Match

S-10: 86.5

Lag 3 Skive 5

Sakskøbing 10m Åben 2018-1Stev - Sakskøbing Skytteforening

Mikkel Kannik
Ølstykke Skytteforening

Klasse R-U17-F

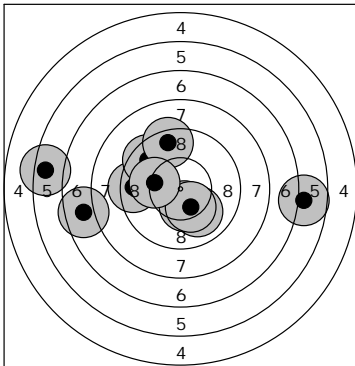

| | | | |
|---|-------|----|-------|
| 1 | 9.3 ← | 6 | 6.3 ← |
| 2 | X.0 ↓ | 7 | 9.5 ↗ |
| 3 | *.3 ↓ | 8 | 9.3 ↑ |
| 4 | 7.5 ← | 9 | 6.7 → |
| 5 | *.2 ↓ | 10 | X.0 ← |

Match

S-10: 89.1

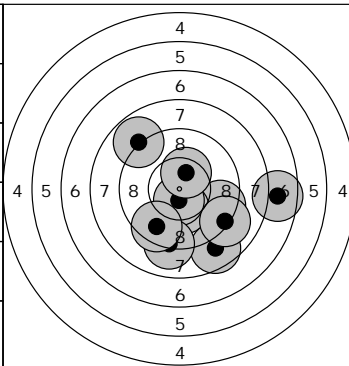

| | | | |
|----|-------|----|-------|
| 31 | 7.6 → | 36 | *.3 ↗ |
| 32 | 9.4 → | 37 | 9.0 ↘ |
| 33 | *.3 ↓ | 38 | 8.8 ↗ |
| 34 | *.6 ○ | 39 | 9.0 ↓ |
| 35 | 8.6 ↓ | 40 | 9.4 ↓ |

Match

S-10: 93.0 SUM: 370.5 (9) TOT: 370.5 (9)

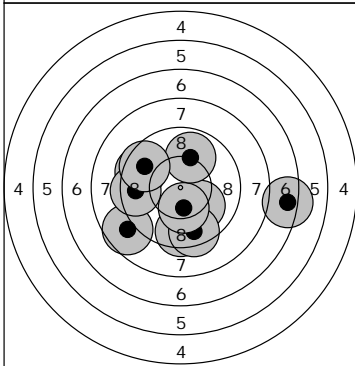

| | | | |
|----|-------|----|-------|
| 11 | X.0 ↓ | 16 | 9.4 ↓ |
| 12 | 9.5 ↖ | 17 | *.2 ↓ |
| 13 | 9.4 ↓ | 18 | 9.9 ↗ |
| 14 | 8.6 ↙ | 19 | 9.5 ↖ |
| 15 | 9.4 ← | 20 | 7.2 → |

Match

S-10: 93.1

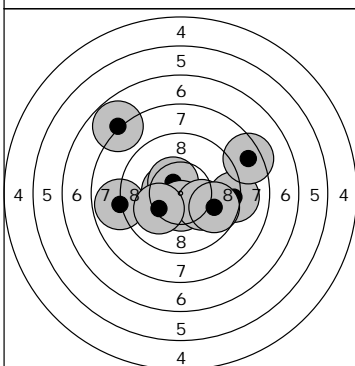

| | | | |
|----|-------|----|-------|
| 21 | *.5 ← | 26 | X.1 → |
| 22 | 9.1 → | 27 | 7.8 ↗ |
| 23 | *.5 ↗ | 28 | 8.8 ← |
| 24 | *.5 ↓ | 29 | X.0 ↙ |
| 25 | 8.3 ↗ | 30 | 9.7 → |

Match

S-10: 95.3

Lag 3 Skive 6

Sakskøbing 10m Åben 2018-1Stev - Sakskøbing Skytteforening

Melika Andersen
Ravnsborg Skytteforening

Klasse R-U15-R-I1

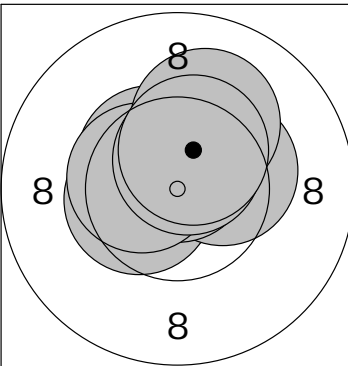

| | | | |
|---|-------|----|-------|
| 1 | *.7 ○ | 6 | *.7 ○ |
| 2 | *.8 ○ | 7 | *.5 ← |
| 3 | *.5 ← | 8 | *.6 ○ |
| 4 | *.4 → | 9 | X.1 ↗ |
| 5 | *.5 ↖ | 10 | *.5 ↗ |

Match
S-10: 105.3

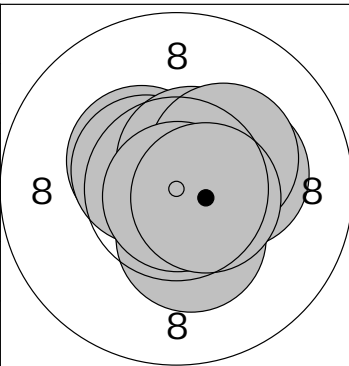

| | | | |
|----|-------|----|-------|
| 31 | *.2 → | 36 | *.5 ↖ |
| 32 | *.4 ↓ | 37 | *.6 ○ |
| 33 | *.7 ○ | 38 | *.3 ↗ |
| 34 | *.7 ○ | 39 | *.9 ○ |
| 35 | *.4 ↖ | 40 | *.6 ○ |

Match
S-10: 105.3 SUM: 417.8 (34) TOT: 417.8 (34)

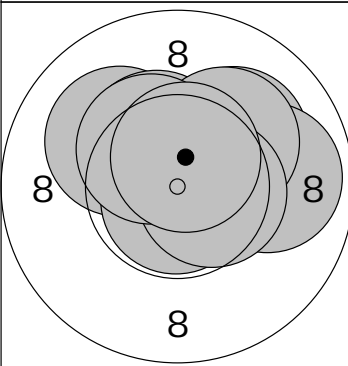

| | | | |
|----|-------|----|-------|
| 11 | X.1 ↖ | 16 | 9.9 → |
| 12 | *.8 ○ | 17 | *.2 ↗ |
| 13 | *.5 ↗ | 18 | *.5 → |
| 14 | *.4 ↖ | 19 | *.4 ↖ |
| 15 | X.1 ↗ | 20 | *.6 ○ |

Match
S-10: 103.5

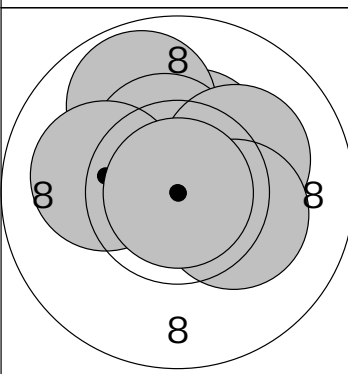

| | | | |
|----|-------|----|-------|
| 21 | *.4 ↗ | 26 | *.4 ↖ |
| 22 | *.7 ○ | 27 | *.2 ↗ |
| 23 | *.3 ↖ | 28 | X.1 ← |
| 24 | 9.8 ↖ | 29 | *.2 → |
| 25 | *.7 ○ | 30 | *.9 ○ |

Match
S-10: 103.7

Lag 3 Skive 8

Sakskøbing 10m Åben 2018-1Stev - Sakskøbing Skytteforening

Xenia Munch Kjær Rasmussen
Ravnsborg Skytteforening

Klasse R-U15-R-I1

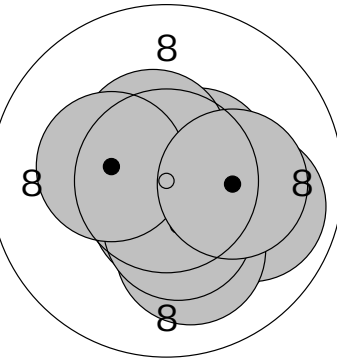

| | | | | | |
|---|-------|--|----|-------|--|
| 1 | *.5 ↖ | | 6 | X.1 ↓ | |
| 2 | *.5 ↗ | | 7 | *.4 ↓ | |
| 3 | *.2 ↓ | | 8 | *.5 ↗ | |
| 4 | 9.9 → | | 9 | *.3 ← | |
| 5 | *.6 ○ | | 10 | *.2 → | |

Match
S-10: 103.2

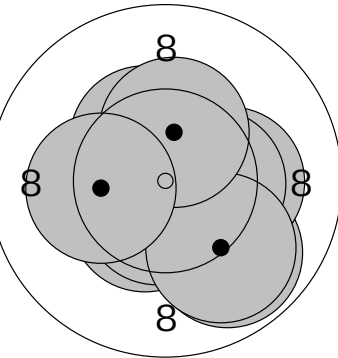

| | | | | | |
|----|-------|--|----|-------|--|
| 31 | *.6 ○ | | 36 | *.4 → | |
| 32 | *.4 ↖ | | 37 | *.6 ○ | |
| 33 | 9.8 ↓ | | 38 | 9.9 ↓ | |
| 34 | *.5 ↙ | | 39 | *.4 ↑ | |
| 35 | *.2 → | | 40 | *.2 ← | |

Match
S-10: 103.6 SUM: 414.1 (34) TOT: 414.1 (34)

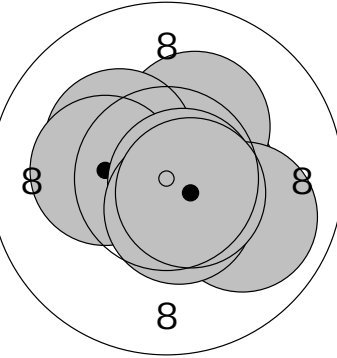

| | | | | | |
|----|-------|--|----|-------|--|
| 11 | *.5 → | | 16 | *.2 ← | |
| 12 | *.6 ○ | | 17 | 9.9 → | |
| 13 | *.6 ○ | | 18 | *.7 ○ | |
| 14 | *.2 ↗ | | 19 | *.6 ○ | |
| 15 | *.3 ↖ | | 20 | *.6 ○ | |

Match
S-10: 104.2

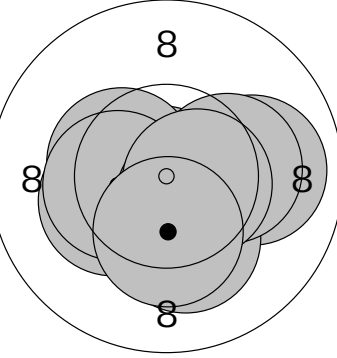

| | | | | | |
|----|-------|--|----|-------|--|
| 21 | *.9 ○ | | 26 | 9.9 → | |
| 22 | *.4 ← | | 27 | *.2 ↓ | |
| 23 | *.3 ← | | 28 | *.2 → | |
| 24 | *.4 ← | | 29 | *.6 ○ | |
| 25 | *.5 ↓ | | 30 | *.3 ↓ | |

Match
S-10: 103.7