

Lag 1 Skive 1

10m Åben 2018-2 - Saks København Skytteforening

Lisbeth Pil
Nykøbing F.

Klasse R-OB

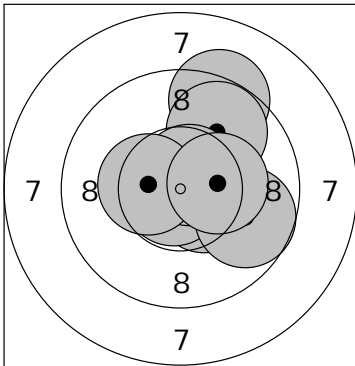

1	9.3 ↗	1,7 3,9	6	9.8 ↗	1,6 2,5
2	*.5 ↘	1,0 -0,6	7	*.7 ○	0,4 0,6
3	*.8 ○	-0,3 0,0	8	*.4 ←	-1,4 0,2
4	*.7 ○	0,4 0,5	9	9.7 →	2,8 -1,2
5	*.8 ○	-0,3 -0,3	10	*.3 →	1,6 0,2

Match
S-10: 103.0

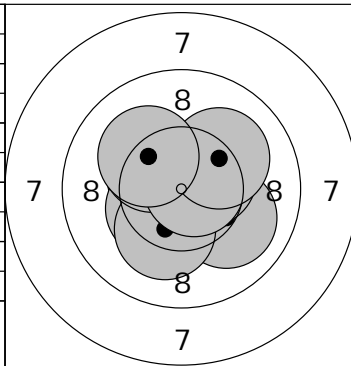

31	*.5 ←	-1,0 0,5	36	*.5 →	1,1 0,5
32	*.7 ○	-0,5 0,4	37	*.3 ↖	-1,3 1,2
33	*.4 ↙	-1,1 -0,9	38	*.7 ○	0,6 0,1
34	X.0 →	2,0 -1,3	39	X.1 ↗	1,6 1,3
35	*.2 ↘	-0,7 -1,8	40	X.1 ↖	-1,4 1,4

Match
S-10: 103.5 SUM: 411.0 (26) TOT: 411.0 (26)

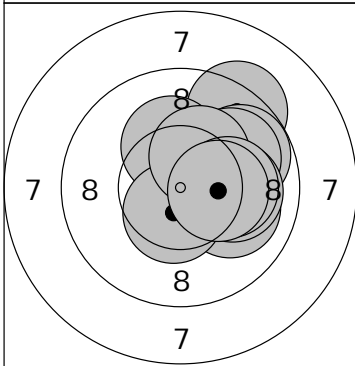

11	X.0 →	2,2 -0,9	16	*.5 ↓	-0,3 -1,1
12	9.3 ↗	2,5 3,3	17	*.3 ↗	0,8 1,4
13	9.8 →	2,6 1,4	18	X.0 →	2,3 -0,2
14	*.2 ↑	-0,4 1,8	19	X.1 →	2,1 0,0
15	9.9 ↗	2,2 1,3	20	*.3 →	1,6 -0,1

Match
S-10: 100.4

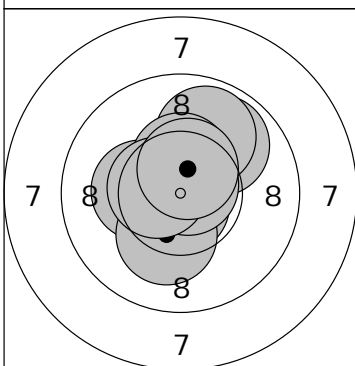

21	*.3 ←	-1,7 0,1	26	*.2 ↓	-0,6 -1,8
22	*.8 ○	-0,1 -0,5	27	*.8 ○	0,3 0,4
23	9.9 ↗	1,7 2,1	28	*.4 ↑	0,0 1,3
24	*.8 ○	0,0 0,4	29	*.5 ←	-1,0 0,2
25	9.9 ↗	1,1 2,5	30	*.5 ↑	0,3 1,1

Match
S-10: 104.1

Lag 1 Skive 2

10m Åben 2018-2 - Saksøbing Skytteforening

Hans Pål
Nykøbing F.

Klasse R-OB

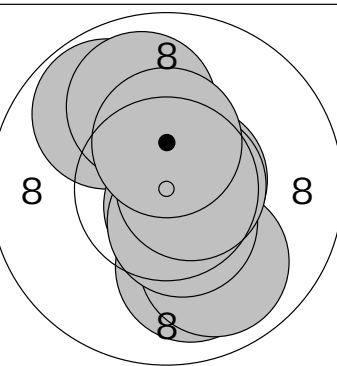

1	*.6 ○	0,5 -0,6	6	*.7 ○	0,4 -0,5
2	X.0 ↓	0,7 -2,3	7	9.9 ↑	-0,7 2,4
3	*.6 ○	0,8 0,3	8	*.5 ↓	0,5 -1,0
4	9.9 ↓	1,4 -2,2	9	*.7 ○	0,7 0,1
5	9.8 ↑	-1,8 2,2	10	*.4 ↑	0,0 1,4

Match
S-10: 103.1

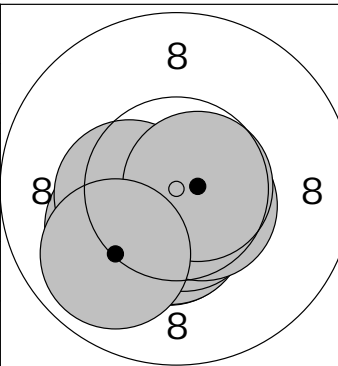

31	*.2 ↙	-1,3 -1,3	36	*.6 ○	-0,7 -0,4
32	*.5 ↓	-0,2 -1,2	37	*.4 ←	-1,4 -0,2
33	*.5 ↓	-0,2 -1,2	38	*.6 ○	0,8 -0,5
34	X.1 ←	-1,7 -1,1	39	*.7 ○	0,6 0,1
35	*.6 ○	0,2 -0,8	40	9.9 ↙	-1,8 -1,9

Match
S-10: 104.1 \bar{x} UM: 412.3 (27) TOT: 412.3 (27)

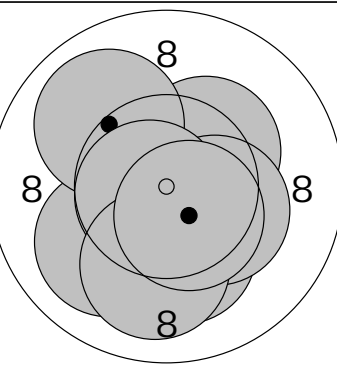

11	X.0 ↙	-1,7 -1,6	16	*.3 →	1,4 -0,7
12	*.6 ○	0,9 -0,1	17	9.9 ↗	-1,7 1,8
13	*.6 ○	0,2 -0,8	18	*.7 ○	-0,5 -0,3
14	*.3 ↗	1,2 1,0	19	X.0 ↓	-0,3 -2,3
15	*.2 ↓	0,4 -1,9	20	*.5 ↓	0,7 -0,9

Match
S-10: 103.1

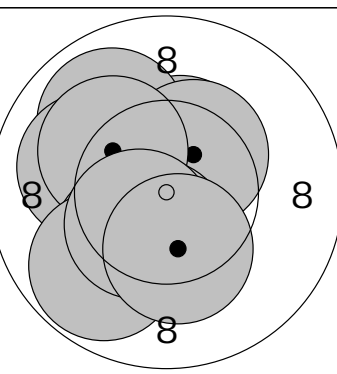

21	*.4 ↑	0,4 1,2	26	*.2 ↙	-1,1 -1,5
22	9.9 ↗	-1,6 2,1	27	*.4 ↓	-0,3 -1,2
23	*.4 ↗	0,8 1,1	28	9.8 ↙	-1,9 -2,2
24	X.0 ←	-2,2 0,8	29	*.5 ↙	-0,8 -0,9
25	X.1 ↗	-1,6 1,2	30	*.3 ↓	0,3 -1,7

Match
S-10: 102.0

Lag 1 Skive 3

10m Åben 2018-2 - Saksøbing Skytteforening

Jesper Langhoff Pedersen
Tingsted

Klasse R-H

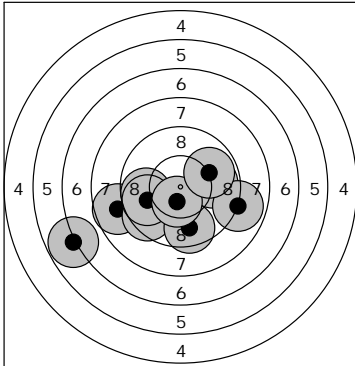

1	8.7	←	-5,4	6	9.7	←	-3,0
			-1,9				-0,6
2	9.8	→	2,8	7	9.5	↓	0,8
			0,4				-3,5
3	6.8	←	-9,2	8	9.7	←	-2,8
			-4,8				-1,2
4	9.4	↙	-2,8	9	*.4	↓	-0,3
			-2,5				-1,3
5	8.9	→	4,9	10	9.8	→	2,5
			-1,6				1,2

Match

S-10: 92.7

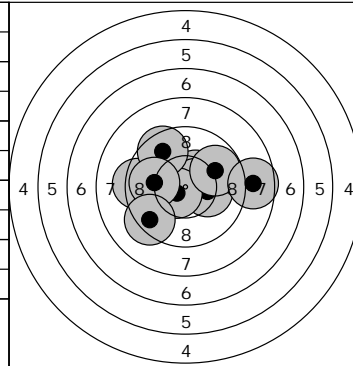

31	*.4	↗	0,9	36	9.8	↗	2,6
			1,0				1,4
32	*.6	○	0,9	37	9.5	↖	-2,0
			0,3				3,0
33	*.2	→	1,9	38	8.6	→	5,8
			-0,4				0,3
34	*.6	○	-0,7	39	9.9	←	-2,7
			-0,5				0,4
35	9.3	←	-4,1	40	9.3	↙	-3,1
			0,3				-2,8

Match

S-10: 98.2

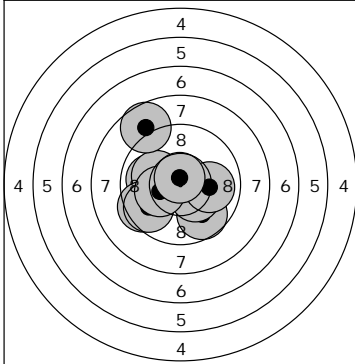

11	9.7	↘	1,9	16	9.4	←	-3,2
			-2,6				-1,9
12	*.3	↘	1,3	17	8.7	↖	-3,0
			-1,0				4,9
13	9.9	←	-2,5	18	9.6	←	-2,7
			0,4				-1,9
14	X.1	↖	-2,0	19	*.2	←	-1,8
			0,8				-0,6
15	X.0	→	2,5	20	*.7	○	-0,1
			-0,2				0,6

Match

S-10: 98.6

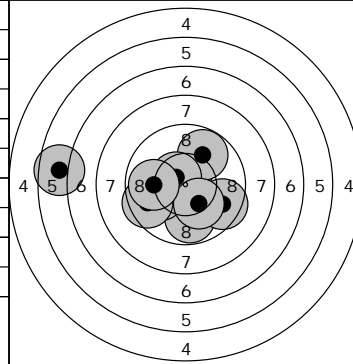

41	*.7	○	0,1	46	*.5	↖	-0,8
			0,7				0,6
42	9.8	↓	0,4	47	9.5	→	3,2
			-2,8				-1,7
43	6.6	←	-10,8	48	9.5	←	-3,3
			1,2				-1,6
44	X.0	←	-2,2	49	X.1	↘	1,2
			-0,9				-1,6
45	9.8	↗	1,5	50	9.9	←	-2,7
			2,5				0,0

Match

S-10: 96.4

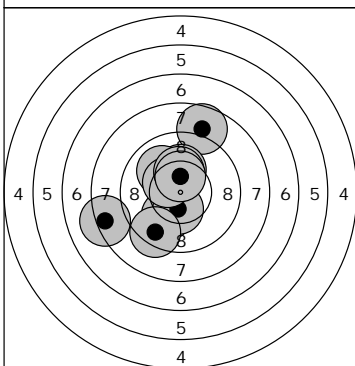

21	8.2	←	-6,5	26	X.0	↖	-1,6
			-2,5				1,8
22	X.0	↘	-1,2	27	*.4	↖	-1,1
			-2,0				0,9
23	*.4	↓	-0,2	28	*.2	↑	-0,1
			-1,4				1,8
24	8.6	↗	1,9	29	*.4	↑	0,0
			5,4				1,4
25	*.2	↑	0,0	30	9.3	↘	-2,2
			2,0				-3,4

Match

S-10: 97.7

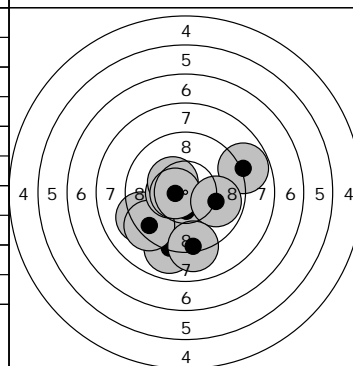

51	8.9	↘	-1,4	56	*.4	←	-1,3
			-4,8				-0,1
52	9.2	←	-3,8	57	*.4	↖	-1,1
			-2,2				0,9
53	8.8	→	5,0	58	*.6	○	-0,9
			2,1				-0,1
54	*.3	↓	0,1	59	9.9	→	2,6
			-1,6				-0,8
55	9.3	←	-3,1	60	9.1	↓	0,7
			-2,9				-4,6

Match

S-10: 96.9 SUM: 580.5 (19) TOT: 580.5 (19)

Lag 1 Skive 4

10m Åben 2018-2 - Saksøbing Skytteforening

Betina Ljunggren Petersen
Tingsted

Klasse R-D

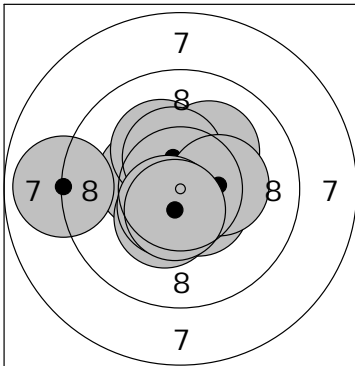

1	*.3 ←	-1,5 0,4	6	*.5 ↘	0,8 -0,7
2	*.2 ↗	-0,8 1,7	7	*.3 →	1,7 0,2
3	X.1 ↗	1,2 1,6	8	*.4 ↓	-0,7 -1,2
4	*.4 ↗	-0,3 1,4	9	*.6 ○	-0,6 -0,8
5	8.9 ←	-5,1 0,1	10	*.6 ○	-0,2 -0,9

Match
S-10: 102.3

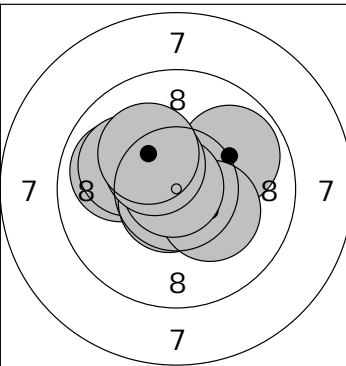

31	9.9 ↗	2,3 1,4	36	*.7 ○	-0,3 -0,6
32	*.8 ○	-0,4 0,0	37	*.2 ↘	1,5 -1,0
33	*.8 ○	-0,3 -0,4	38	*.9 ○	-0,1 0,1
34	9.9 ←	-2,5 0,8	39	*.4 ↗	-0,9 1,0
35	X.0 ←	-2,1 1,0	40	*.2 ↗	-1,2 1,5

Match
S-10: 103.8

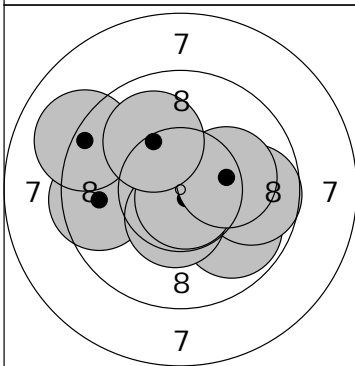

11	*.6 ○	0,5 -0,6	16	*.5 ↓	-0,2 -1,2
12	9.8 ↘	2,2 -1,7	17	9.1 ↖	-4,2 2,1
13	9.5 ←	-3,6 -0,4	18	*.8 ○	0,2 -0,4
14	*.8 ○	0,1 -0,4	19	X.1 →	2,0 0,5
15	9.7 →	3,1 -0,2	20	X.0 ↗	-1,2 2,1

Match
S-10: 100.9

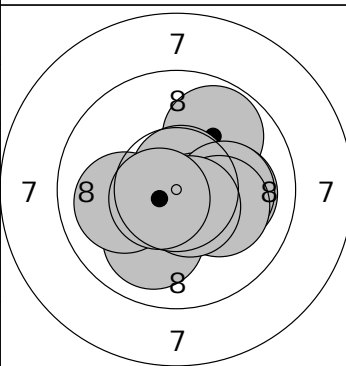

41	9.8 ↗	1,6 2,3	46	X.0 ←	-2,3 -0,6
42	*.7 ○	0,2 0,6	47	X.1 →	2,1 -0,1
43	X.0 ↓	-1,0 -2,1	48	X.1 →	1,9 -0,7
44	*.5 ↘	0,9 -0,6	49	*.6 ○	0,6 -0,7
45	X.1 →	2,2 -0,2	50	*.6 ○	-0,7 -0,4

Match
S-10: 102.5

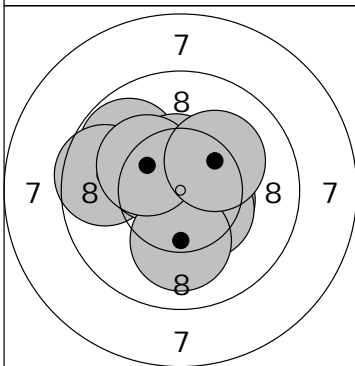

21	*.6 ○	-0,2 0,8	26	*.4 ↗	-1,1 0,8
22	*.5 ↘	1,1 -0,4	27	*.4 ↓	1,0 -0,8
23	9.8 ↗	-2,2 1,8	28	X.1 ↓	0,0 -2,2
24	9.6 ←	-3,3 0,7	29	*.2 ↖	-1,5 1,1
25	*.5 ↗	-0,2 1,1	30	*.2 ↗	1,5 1,3

Match
S-10: 102.3

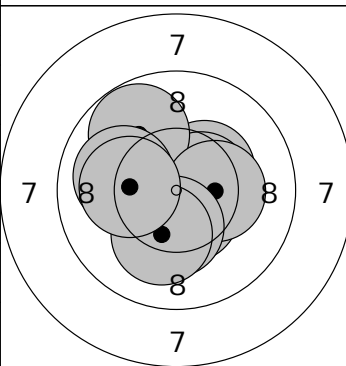

51	*.4 ↗	1,2 0,8	56	X.0 ←	-2,3 0,6
52	*.4 ↓	-0,6 -1,1	57	*.3 →	1,7 0,0
53	*.5 →	1,1 0,3	58	*.3 ↓	-0,1 -1,6
54	9.8 ↖	-1,6 2,4	59	X.1 ↓	-0,6 -1,9
55	*.5 ↓	0,5 -0,9	60	X.1 ←	-2,0 0,1

Match
S-10: 102.4

SUM: 614.2 (36) TOT: 614.2 (36)

Lag 1 Skive 5

10m Åben 2018-2 - Saksøbing Skytteforening

Mads Holten Mossin
Tingsted

Klasse R-HJ

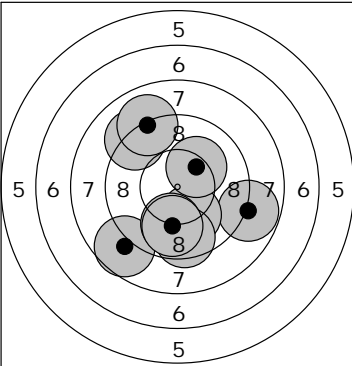

1	8.8	→	5,1 -1,7	6	9.5	↓	0,5 -3,6
2	9.1	↗	-3,1 3,4	7	9.9	↓	-0,5 -2,6
3	9.9	↓	0,4 -2,5	8	9.8	↓	-0,4 -2,8
4	X.1	↓	1,0 -2,0	9	9.0	↗	-2,2 4,4
5	8.7	↙	-3,8 -4,3	10	*.2	↗	1,4 1,4

Match
S-10: 95.0

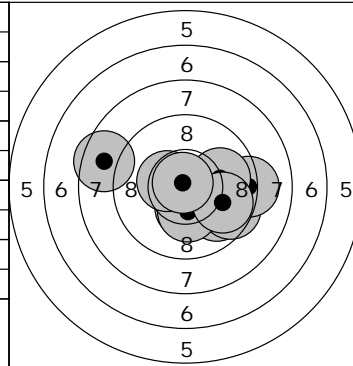

31	8.5	←	-5,8 1,8	36	*.2	↓	0,2 -1,8
32	9.8	↘	2,3 -1,7	37	*.4	←	-1,3 0,4
33	*.3	↓	0,0 -1,5	38	9.9	→	2,5 0,6
34	9.5	→	3,3 -1,6	39	9.8	↘	2,7 -1,1
35	9.1	→	4,5 0,0	40	*.8	○	-0,2 0,3

Match
S-10: 98.3

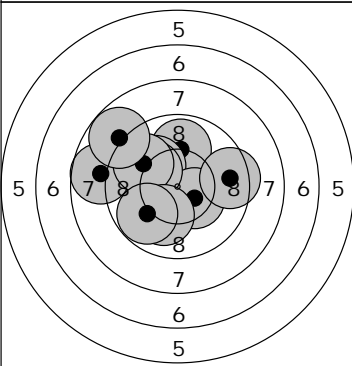

11	9.9	↑	0,2 2,7	16	8.7	←	-5,5 0,9
12	X.1	↗	-1,6 1,5	17	9.8	↖	-2,5 1,6
13	*.4	↘	1,2 -0,8	18	X.0	↓	-1,0 -2,1
14	X.1	↗	-1,8 1,1	19	8.8	↗	-4,2 3,5
15	9.4	→	3,8 0,6	20	9.8	↙	-2,2 -2,0

Match
S-10: 97.0

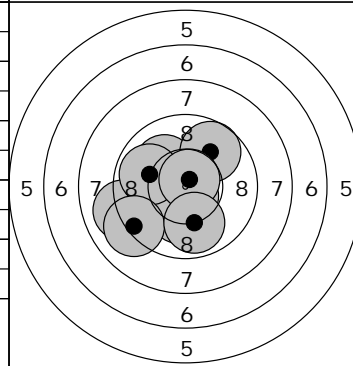

41	*.8	○	-0,2 -0,4	46	9.9	←	-2,6 0,9
42	*.7	○	0,2 -0,7	47	9.7	↗	1,8 2,5
43	*.2	↓	-0,4 -1,9	48	*.7	○	0,3 0,5
44	9.0	←	-4,5 -1,7	49	9.1	↙	-3,7 -2,8
45	X.1	↗	-1,5 1,5	50	9.9	↓	0,6 -2,6

Match
S-10: 100.1

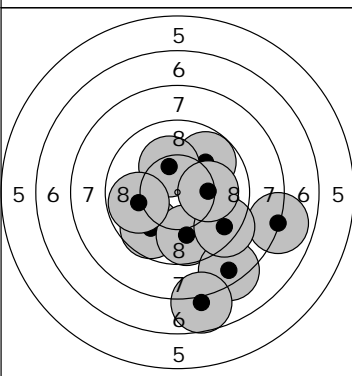

21	9.8	↗	2,0 2,2	26	7.9	→	7,2 -2,2
22	9.7	↙	-1,9 -2,6	27	7.7	↓	1,7 -7,9
23	*.2	↑	-0,6 1,9	28	9.8	←	-2,8 -0,8
24	9.7	↓	0,7 -3,1	29	9.3	↘	3,4 -2,5
25	8.3	↘	3,7 -5,6	30	X.1	→	2,2 0,1

Match
S-10: 92.5

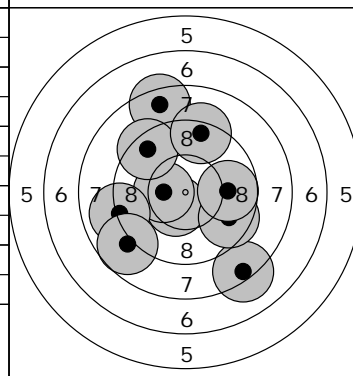

51	*.5	↙	-0,7 -1,0	56	9.3	↖	-2,7 3,1
52	8.3	↑	-1,8 6,3	57	9.2	↑	1,1 4,2
53	8.1	↘	4,2 -5,7	58	9.7	→	3,1 0,1
54	*.3	←	-1,6 0,0	59	9.0	←	-4,7 -1,5
55	9.5	↘	3,1 -1,8	60	8.7	↙	-4,2 -3,7

Match
S-10: 92.6 SUM: 575.5 (13) TOT: 575.5 (13)

Lag 1 Skive 6

10m Åben 2018-2 - Sakskøbing Skytteforening

Allan Stryhn
Tingsted

Klasse R-Å

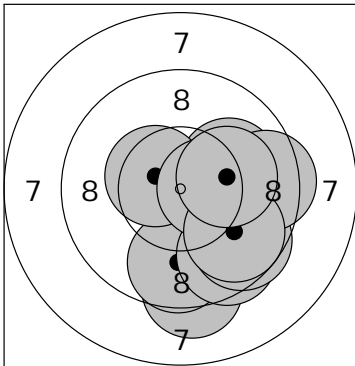

1	9.2 ↓	0,5 -4,3	6	9.6 ↘	2,7 -2,2
2	9.7 ↓	-0,1 -3,2	7	*.5 →	1,2 0,0
3	9.5 ↓	2,0 -2,9	8	9.4 →	3,7 0,3
4	X.0 →	2,1 0,9	9	9.7 ↘	2,4 -1,9
5	*.5 ←	-1,1 0,6	10	X.1 →	2,0 0,5

Match

S-10: 98.2

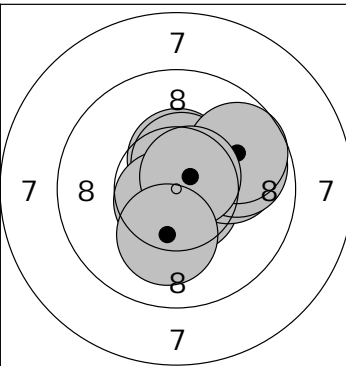

31	*.4 ↑	0,1 1,3	36	9.8 →	2,6 1,0
32	*.5 ↑	0,2 1,1	37	*.6 ○	-0,5 -0,5
33	*.7 ○	0,4 -0,4	38	9.7 ↗	2,7 1,6
34	*.6 ○	0,5 -0,6	39	*.6 ○	0,6 0,5
35	X.0 →	2,3 0,7	40	X.1 ↓	-0,4 -2,0

Match

S-10: 103.0

SUM: 406.8 (24) TOT: 406.8 (24)

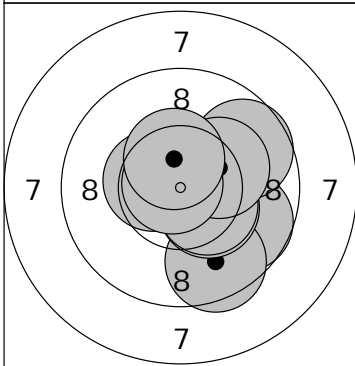

11	9.7 ↘	2,7 -1,5	16	*.5 →	1,1 0,5
12	9.5 ↓	1,5 -3,2	17	*.4 ↘	1,2 -0,7
13	*.3 ↘	1,2 -0,9	18	*.2 ↗	1,7 0,9
14	9.7 ↗	2,7 1,6	19	*.8 ○	-0,4 0,2
15	*.5 ←	-1,2 0,3	20	*.4 ↑	-0,3 1,3

Match

S-10: 102.0

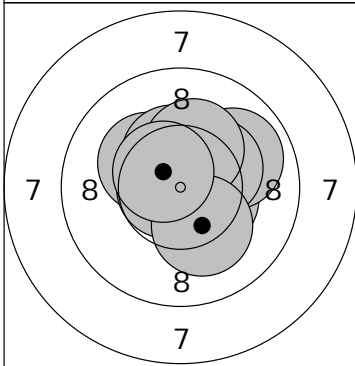

21	*.4 ↘	1,2 -0,5	26	*.8 ○	-0,1 0,4
22	*.2 ↗	-1,4 1,1	27	*.3 ↗	1,4 0,8
23	9.9 ↗	2,3 1,2	28	*.2 ↑	0,6 1,7
24	*.4 ↑	-0,4 1,4	29	*.2 ↓	0,9 -1,7
25	*.7 ○	-0,6 0,0	30	*.5 ↗	-0,8 0,7

Match

S-10: 103.6

Lag 1 Skive 7

10m Åben 2018-2 - Sakskøbing Skytteforening

Jonas Stryhn
Tingsted

Klasse R-U13-S-I1

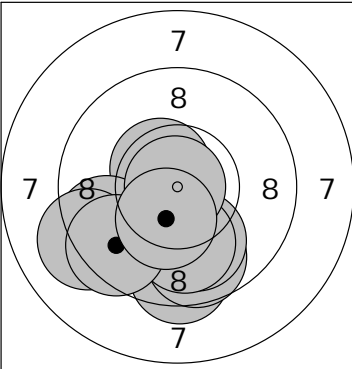

1	*.5 ↗	-0,7 0,8	6	X.0 ↓	0,3 -2,4
2	9.4 ↓	0,1 -3,8	7	9.1 ←	-3,9 -2,3
3	9.5 ←	-3,1 -1,7	8	9.5 ↙	-2,7 -2,6
4	9.7 ↓	0,8 -3,1	9	*.9 ○	-0,1 0,0
5	X.0 ↓	0,8 -2,4	10	*.4 ↓	-0,5 -1,4

Match
S-10: 99.0

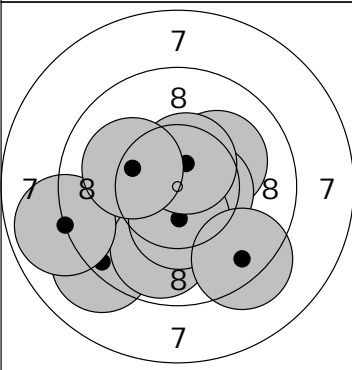

11	X.1 ↗	1,7 1,1	16	8.9 ←	-4,9 -1,7
12	*.2 ↓	0,4 -1,9	17	*.4 ↓	0,1 -1,4
13	*.5 →	1,1 -0,2	18	*.5 ↗	0,4 1,0
14	9.1 ←	-3,3 -3,3	19	9.3 ↓	2,8 -3,2
15	9.8 ↓	-0,7 -2,7	20	X.1 ←	-2,0 0,8

Match
S-10: 98.9

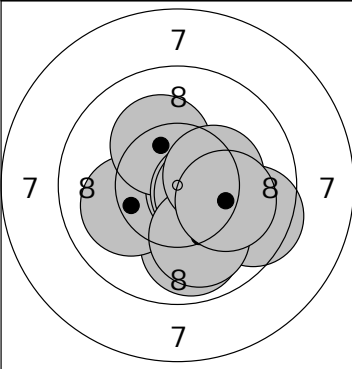

21	9.9 ↓	0,6 -2,6	26	*.4 →	1,2 -0,4
22	X.1 ←	-2,0 -0,9	27	9.5 →	3,3 -1,3
23	*.6 ○	0,8 -0,2	28	X.0 ↓	1,0 -2,2
24	*.2 ↗	-0,7 1,7	29	*.3 →	1,6 0,4
25	*.5 →	1,0 -0,3	30	X.1 →	2,1 -0,7

Match
S-10: 101.6 SUM: 299.5 (12) TOT: 299.5 (12)

Lag 1 Skive 8

10m Åben 2018-2 - Saksøbing Skytteforening

Hans Helge Løje
Saksøbing

Klasse R-OB

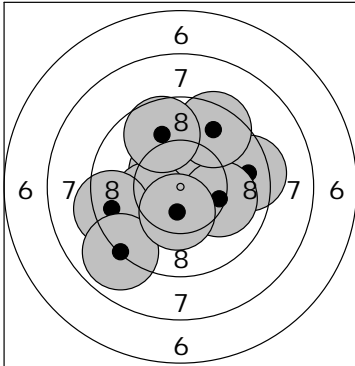

Match
S-10: 98.3

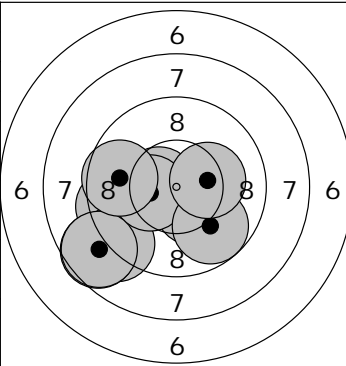

Match
S-10: 96.4 SUM: 398.7 (20) TOT: 398.7 (20)

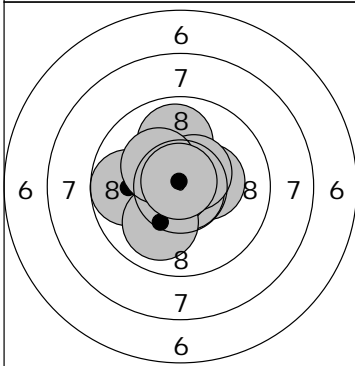

Match
S-10: 103.5

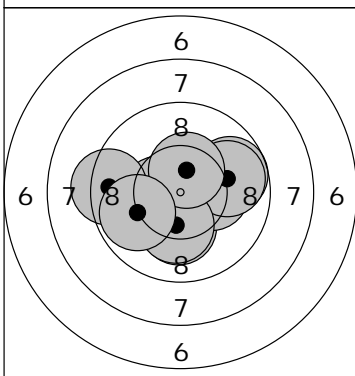

Match
S-10: 100.5