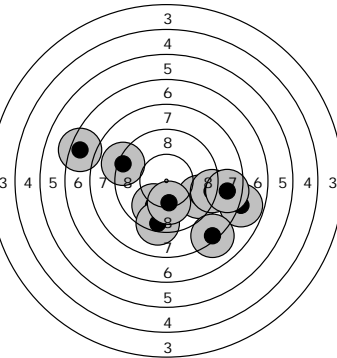
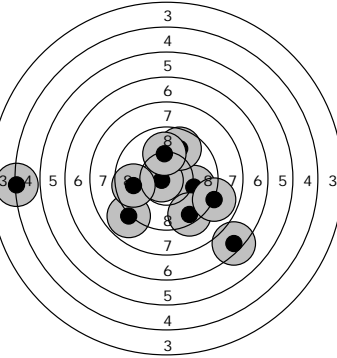
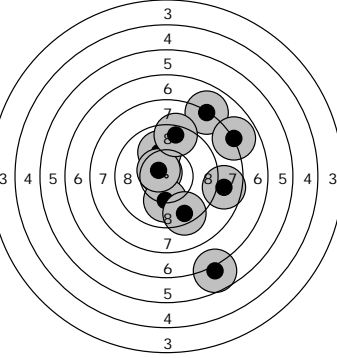
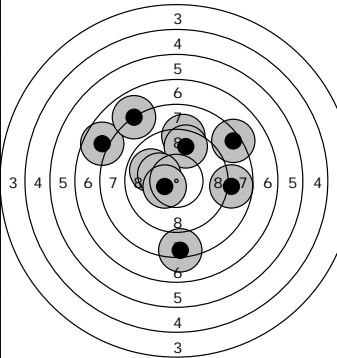
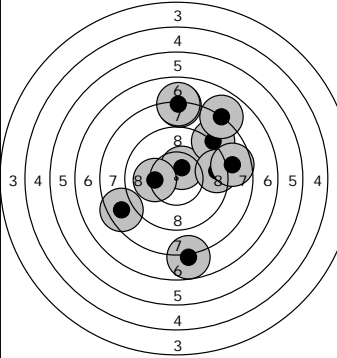
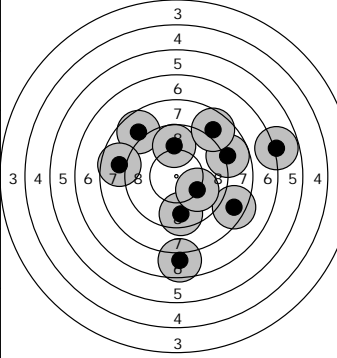

Lag 7 Skive 1

10m Åben 2018-2 - Sakskøbing Skytteforening

Mikkel Kannik
Ølstykke

Klasse R-HJ

	1	7.8	→	6	8.5	→
	2	9.5	↘	7	8.1	↙
	3	9.1	↗	8	9.8	↘
	4	7.3	↗	9	9.2	↘
	5	9.1	→	10	X.1	↘
	Match S-10: 88.5					
	11	8.8	↙	16	9.6	↗
	12	4.9	←	17	X.0	↑
	13	9.8	→	18	9.6	←
	14	*.7	○	19	7.2	↘
	15	9.2	↘	20	8.9	→
	Match S-10: 88.7					
	21	7.9	↗	26	*.6	○
	22	*.7	○	27	9.3	↑
	23	X.0	↓	28	7.9	↗
	24	9.3	↘	29	6.7	↘
	25	9.9	↑	30	8.6	→
	Match S-10: 90.9					
	31	9.1	↑	36	7.9	↖
	32	9.5	↑	37	9.9	↖
	33	8.2	↗	38	8.2	↓
	34	8.7	→	39	*.2	↖
	35	7.6	↖	40	*.4	↖
	Match S-10: 89.7					
	41	8.4	↙	46	8.6	→
	42	*.5	↑	47	8.0	↑
	43	8.9	↗	48	7.8	↓
	44	7.9	↗	49	X.1	←
	45	9.3	→	50	8.0	↑
	Match S-10: 87.5					
	51	8.6	↖	56	8.3	↘
	52	9.4	↓	57	X.0	↘
	53	9.7	↑	58	8.7	↗
	54	8.6	←	59	6.8	→
	55	7.6	↓	60	8.6	↗
	Match S-10: 86.3 SUM: 531.6 (6) TOT: 531.6 (6)					

Lag 7
Skive 2

10m Åben 2018-2 - Sakskøbing Skytteforening

Oliver Dall Hansen
Ølstykke

Klasse R-HJ

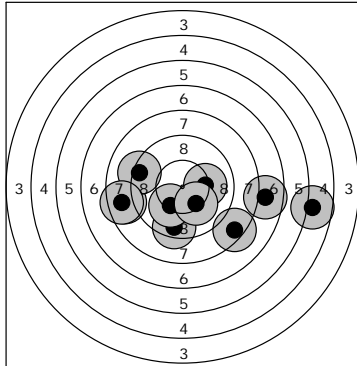

1	5.7 →	6	X.0 →
2	8.6 ←	7	8.2 ↘
3	9.3 ↓	8	8.4 ←
4	9.1 ←	9	7.6 →
5	X.1 ↙	10	X.1 ↘

Match
S-10: 87.1

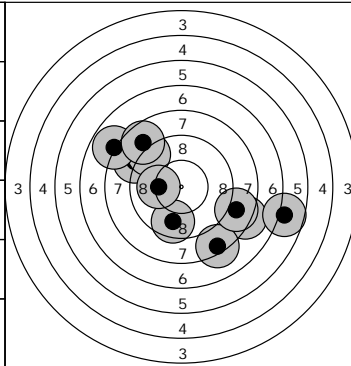

31	8.8 ←	36	9.5 ↓
32	9.1 ↗	37	8.6 →
33	7.8 ↖	38	X.0 ←
34	8.1 →	39	6.7 →
35	8.2 ↓	40	8.6 ↗

Match
S-10: 85.4

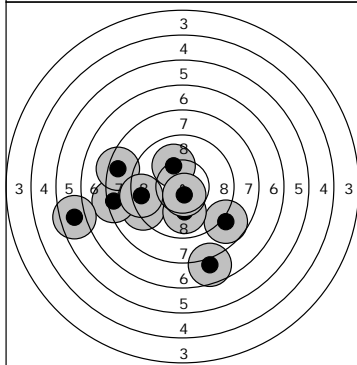

11	9.1 ←	16	X.0 ↗
12	8.1 ←	17	9.3 ←
13	8.3 ←	18	8.7 ↘
14	7.6 ↓	19	9.9 ↓
15	6.5 ←	20	*.6 ○

Match
S-10: 88.1

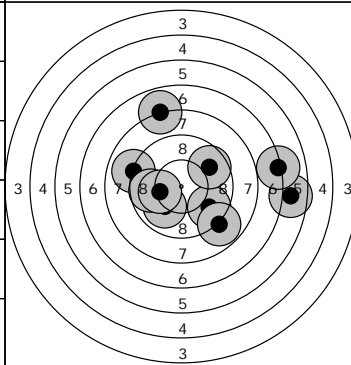

41	7.9 ↗	46	8.9 ←
42	9.6 ↘	47	6.6 →
43	8.8 ↘	48	7.0 →
44	9.6 ↗	49	9.7 ←
45	9.9 ↙	50	X.1 ←

Match
S-10: 88.1

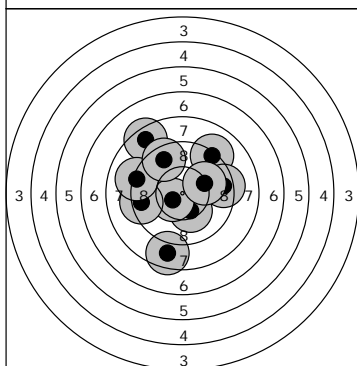

21	*.2 ↓	26	9.0 ↗
22	8.3 ↗	27	9.3 →
23	*.5 ←	28	9.0 ←
24	8.5 ↓	29	9.4 ↗
25	9.3 ←	30	X.0 →

Match
S-10: 93.5

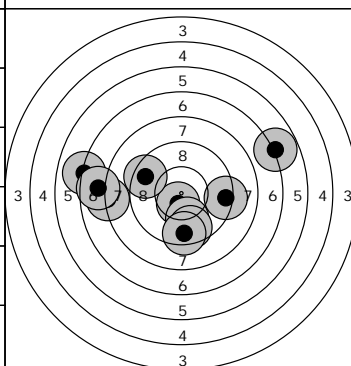

51	9.2 →	56	9.9 ↓
52	*.5 ↓	57	9.5 ↓
53	7.0 ←	58	7.6 ←
54	9.4 ←	59	6.8 ↗
55	8.0 ←	60	9.3 ↓

Match
S-10: 87.2 SUM: 529.4 (4) TOT: 529.4 (4)

Lag 7 Skive 3

10m Åben 2018-2 - Saks København Skytteforening

Natasja Buchholdt
Ølstykke

Klasse R-D

	1	*.8 ○	6	*.7 ○		31	*.3 →	36	*.2 ←
	2	*.5 →	7	*.5 →		32	*.5 ↑	37	X.1 ←
	3	*.7 ○	8	X.1 ←		33	*.5 ↓	38	X.0 ←
	4	*.5 ↓	9	*.9 ○		34	*.4 ↙	39	*.3 ↗
	5	9.7 ↓	10	*.8 ○		35	X.0 ↑	40	*.3 ↗
	Match S-10: 105.2					Match S-10: 102.6			
	11	9.8 ↑	16	*.6 ○		41	X.1 ↗	46	*.8 ○
	12	*.3 ↗	17	*.8 ○		42	*.2 ↓	47	*.6 ○
	13	*.2 →	18	*.6 ○		43	9.8 ↓	48	X.0 ↑
	14	*.8 ○	19	*.6 ○		44	*.4 ↓	49	*.2 ↗
	15	*.5 →	20	*.2 ←		45	*.2 ↗	50	*.2 ↓
	Match S-10: 104.4					Match S-10: 102.5			
	21	X.0 ↘	26	*.8 ○		51	*.3 ↗	56	*.2 ←
	22	9.9 ↗	27	*.3 ↓		52	*.5 →	57	*.7 ○
	23	*.2 ↑	28	*.5 →		53	X.0 ↑	58	*.6 ○
	24	*.2 ↗	29	*.6 ○		54	*.8 ○	59	*.4 ↑
	25	*.8 ○	30	*.4 ←		55	9.7 →	60	*.3 ↓
	Match S-10: 103.7					Match S-10: 103.5			
SUM: 621.9 (47) TOT: 621.9 (47)									

Lag 7 Skive 4

10m Åben 2018-2 - Saksøbing Skytteforening

Diana Henriksen
Ballerup

Klasse R-D

	1	*.5 ←	6	*.4 ↙		31	*.9 ○	36	*.3 ↖
	2	*.6 ○	7	9.7 ↗		32	X.1 ←	37	*.4 →
	3	*.6 ○	8	*.2 ↗		33	*.7 ○	38	*.7 ○
	4	*.5 ↑	9	*.6 ○		34	9.8 ↓	39	*.3 ←
	5	*.6 ○	10	9.9 ↘		35	*.3 ↘	40	*.9 ○
	Match S-10: 103.6					Match S-10: 104.4			
	11	*.6 ○	16	9.9 ↗		41	9.7 →	46	*.3 →
	12	*.2 ↗	17	9.8 ↖		42	*.3 →	47	*.5 ↑
	13	X.1 ↑	18	*.8 ○		43	X.1 ↓	48	*.6 ○
	14	*.8 ○	19	X.1 ←		44	*.7 ○	49	X.0 ↑
	15	*.3 →	20	X.0 ↘		45	9.9 ↓	50	*.5 ←
	Match S-10: 102.6					Match S-10: 102.6			
	21	*.2 ↓	26	X.1 ↘		51	*.6 ○	56	9.3 ↖
	22	X.1 ↑	27	*.5 ←		52	*.2 ↗	57	*.2 ←
	23	*.3 →	28	*.3 ↖		53	*.7 ○	58	*.2 ↗
	24	*.5 →	29	*.4 ↗		54	*.5 →	59	*.2 ↗
	25	X.0 ←	30	*.6 ○		55	9.8 ↗	60	*.4 ←
	Match S-10: 103.0					Match S-10: 102.6			
Σ: 618.3 (42) TOT: 618.3 (42)									

Lag 7 Skive 5

10m Åben 2018-2 - Sakskøbing Skytteforening

Børge Pehrson
Damsholte

Klasse R-OB

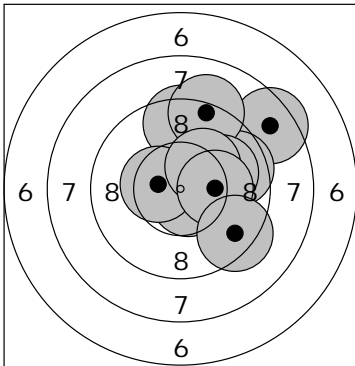

1	8.4 ↗	6	9.1 ↑
2	9.4 ↑	7	X.0 →
3	9.6 →	8	*.2 ↗
4	*.7 ○	9	X.1 →
5	*.4 ←	10	9.3 ↘

Match
S-10: 97.2

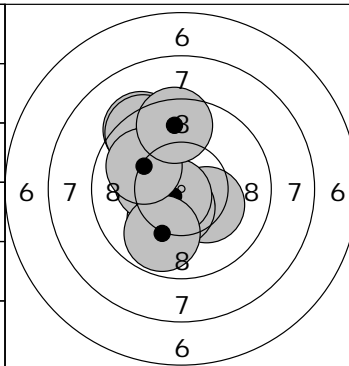

31	9.3 ↖	36	*.7 ○
32	*.2 ↓	37	9.8 ↓
33	*.3 ↘	38	9.4 ↗
34	*.3 ←	39	9.9 ↖
35	*.5 ↓	40	9.5 ↑

Match
S-10: 99.9 SUM: 397.2 (16) TOT: 397.2 (16)

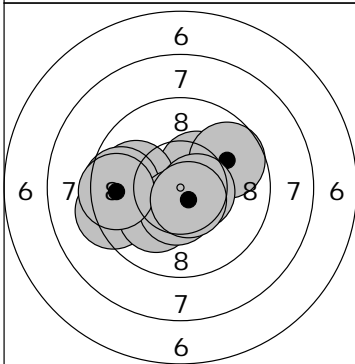

11	*.4 ↗	16	9.6 ←
12	9.7 ↗	17	*.6 ○
13	9.3 ←	18	*.5 ↓
14	X.1 ↙	19	9.5 ←
15	9.9 ←	20	*.6 ○

Match
S-10: 100.2

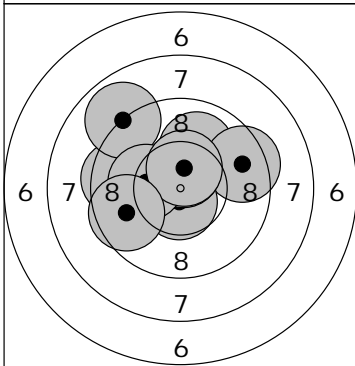

21	9.5 ←	26	*.6 ○
22	X.0 ↑	27	*.5 ↑
23	8.9 ↖	28	X.1 ←
24	9.4 →	29	*.5 ↑
25	*.8 ○	30	9.6 ←

Match
S-10: 99.9

Lag 7 Skive 6

10m Åben 2018-2 - Sakskøbing Skytteforening

Frederikke Frederiksen
Damsholte

Klasse R-D

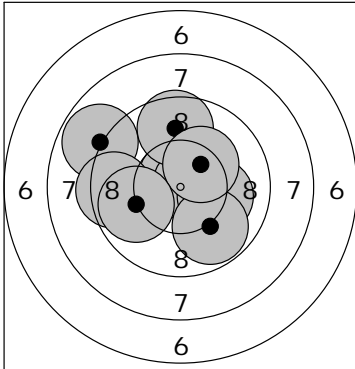

1	*.3 ↗	6	9.6 ↑
2	*.7 ○	7	9.8 ↘
3	*.7 ○	8	*.2 ↗
4	X.1 →	9	9.4 ←
5	8.8 ↖	10	9.8 ←

Match
S-10: 99.4

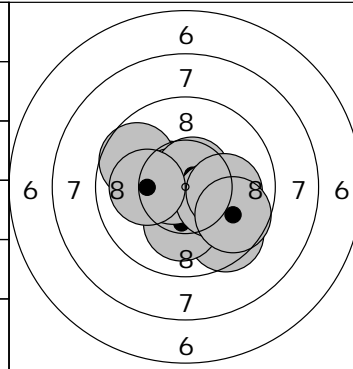

31	9.5 ↘	36	*.6 ○
32	X.1 ↓	37	*.2 ↘
33	*.5 ↖	38	X.0 →
34	9.7 ↖	39	X.1 ←
35	*.7 ○	40	9.7 ↘

Match
S-10: 101.1

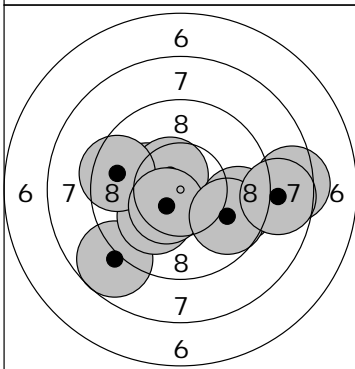

11	*.2 ←	16	9.4 ←
12	*.5 ↗	17	*.5 ↘
13	8.7 ↘	18	9.6 →
14	8.4 →	19	9.7 ↘
15	X.1 ↙	20	8.7 →

Match
S-10: 95.8

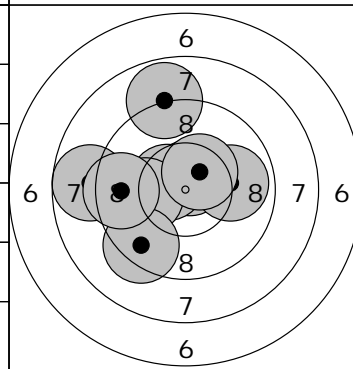

41	*.7 ○	46	X.0 ←
42	8.8 ↑	47	8.7 ←
43	9.8 ←	48	9.3 ↘
44	9.9 →	49	9.5 ←
45	*.5 ↖	50	*.4 ↗

Match
S-10: 97.6

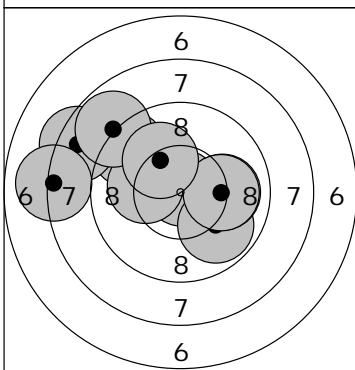

21	*.8 ○	26	X.0 →
22	9.4 ↗	27	8.8 ↗
23	X.1 ←	28	X.0 →
24	8.3 ↖	29	X.1 ↗
25	9.8 ↘	30	8.0 ←

Match
S-10: 95.3

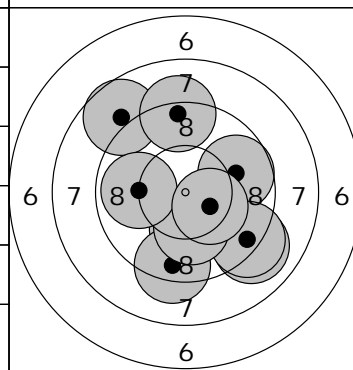

51	9.0 ↘	56	X.1 ↓
52	X.1 ↓	57	8.7 ↗
53	9.7 →	58	9.1 ↑
54	9.2 ↘	59	9.9 ←
55	9.2 ↓	60	*.3 ↘

Match
S-10: 95.3 SUM: 584.5 (16) TOT: 584.5 (16)

Lag 7 Skive 7

10m Åben 2018-2 - Saksøbing Skytteforening

Claus Frederiksen
Damsholte

Klasse R-OB

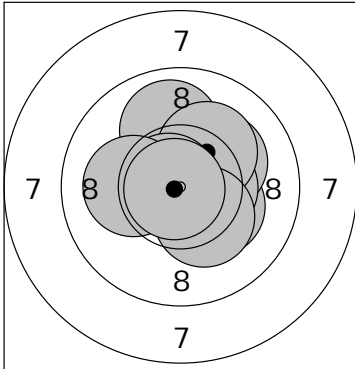

1	*.3 ↘	6	*.2 ↗
2	*.6 ○	7	*.3 ↓
3	9.9 ↑	8	*.7 ○
4	*.2 ↗	9	X.1 ←
5	*.5 →	10	*.8 ○

Match
S-10: 103.6

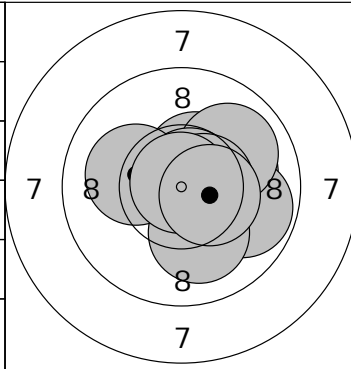

31	X.1 →	36	*.7 ○
32	9.8 →	37	*.6 ○
33	X.1 ↓	38	X.1 ←
34	*.5 ↗	39	*.9 ○
35	X.0 ↗	40	*.4 →

Match
S-10: 103.2
SUM: 412.9 (27) TOT: 412.9 (27)

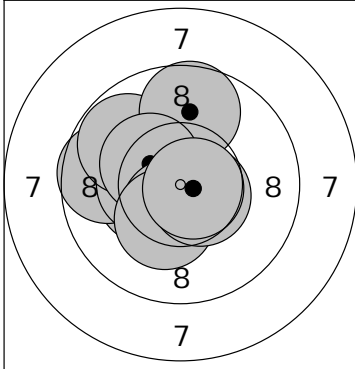

11	*.4 ←	16	*.3 ↖
12	9.7 ←	17	*.5 ↓
13	*.4 ←	18	*.3 ↓
14	9.8 ↗	19	*.6 ○
15	9.7 ↑	20	*.7 ○

Match
S-10: 102.4

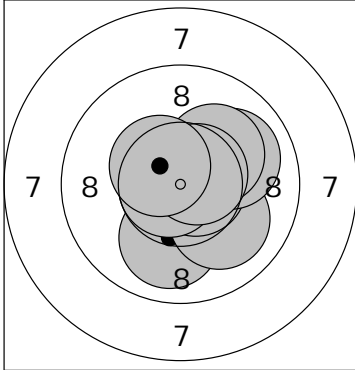

21	*.6 ○	26	X.0 ↗
22	*.4 →	27	*.7 ○
23	X.0 ↓	28	*.2 ↗
24	X.0 ↓	29	*.6 ○
25	*.7 ○	30	*.5 ↖

Match
S-10: 103.7

Lag 7 Skive 8

10m Åben 2018-2 - Saksøbing Skytteforening

Poul Kristensen
Hvidovre

Klasse R-S2

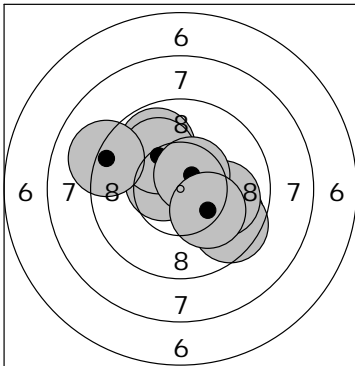

1	9.8 ↘	6	X.1 →
2	9.8 ↗	7	9.1 ←
3	*.5 ←	8	X.0 →
4	X.0 ↗	9	*.5 ↗
5	9.5 ↘	10	X.1 ↘

Match
S-10: 99.4

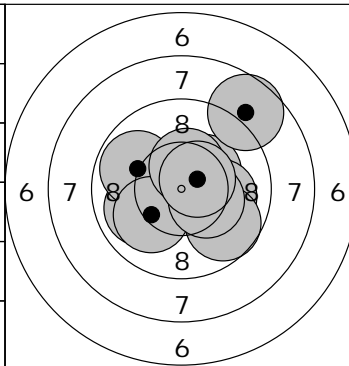

31	*.3 ↗	36	X.0 ↙
32	X.1 →	37	*.4 ↑
33	9.9 ←	38	*.3 →
34	9.8 ←	39	*.5 ↗
35	9.7 ↘	40	8.6 ↗

Match
S-10: 99.6 SUM: 403.4 (18) TOT: 403.4 (18)

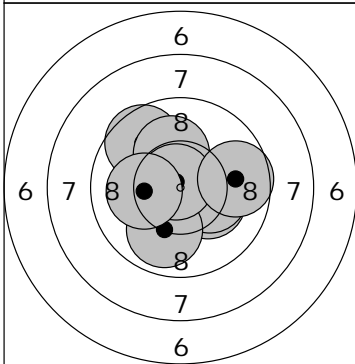

11	*.2 ↘	16	*.3 →
12	*.5 ←	17	9.9 ↓
13	*.3 ←	18	*.8 ○
14	9.6 ↗	19	9.7 →
15	X.1 ↑	20	X.1 ←

Match
S-10: 101.5

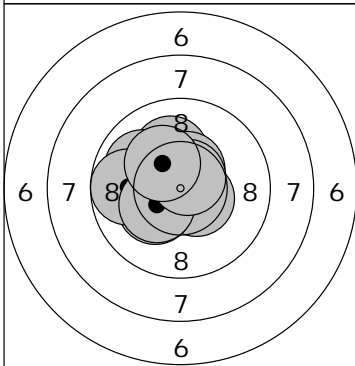

21	X.1 ↑	26	X.0 ↙
22	*.8 ○	27	9.7 ←
23	*.5 ↘	28	*.3 ↙
24	*.2 ↙	29	*.6 ○
25	*.5 ↑	30	*.2 ↗

Match
S-10: 102.9